

# Surface Mount Voltage Controlled Oscillator

## JTOS-100+ JTOS-100

### Linear Tuning 50 to 100 MHz

#### Features

- low phase noise, -140 dBc/Hz at 1 MHz offset
- linear tuning sensitivity, 3.7-4.8 MHz/V typ.
- aqueous washable

#### Applications

- signal generators
- VHF

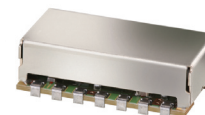

CASE STYLE: BK377  
PRICE: \$13.95 ea. QTY (5-49)

**+ RoHS compliant in accordance with EU Directive (2002/95/EC)**

The +Suffix identifies RoHS Compliance. See our web site for RoHS Compliance methodologies and qualifications.

#### Electrical Specifications

FREQUENCY (MHz)		POWER OUTPUT (dBm)	TUNING VOLTAGE (V)		PHASE NOISE (dBc/Hz) SSB at offset frequencies: Typ.				PULLING pk-pk @ 12 dB (MHz)	PUSHING (MHz/V)	TUNING SENSITIVITY (MHz/V)	HARMONICS (dBc)		3 dB MODULATION BANDWIDTH (MHz)	DC OPERATING POWER	
Min.	Max.	Typ.	Min.	Max.	1 kHz	10 kHz	100 kHz	1 MHz	Typ.	Typ.	Typ.	Typ.	Max.	Typ.	Vcc (volts)	Current (mA) Max.
50	100	+8.3	1	16	-83	-108	-128	-140	0.6	0.2	3.7-4.8	-35	-20	0.1	12	18

#### Pin Connections

RF OUT	13
VCC	2
V-TUNE	5
GROUND	1,3,4,6,7,8,9,10,11,12,14

#### Maximum Ratings

Operating Temperature	-55°C to 85°C
Storage Temperature	-55°C to 100°C
Absolute Max. Supply Voltage (Vcc)	+16V
Absolute Max. Tuning Voltage (Vtune)	+18V

all specifications: 50 ohm system

#### Outline Drawing

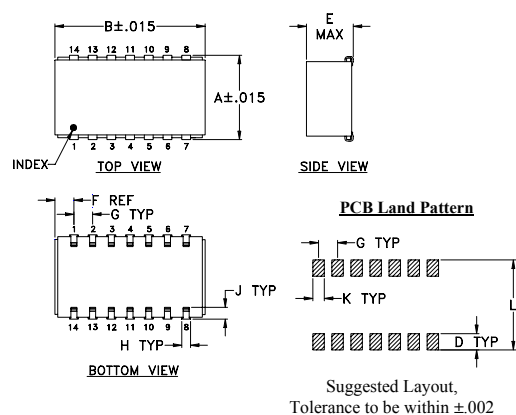

Demo Board MCL PIN: TB-04  
Suggested PCB Layout (PL-005)

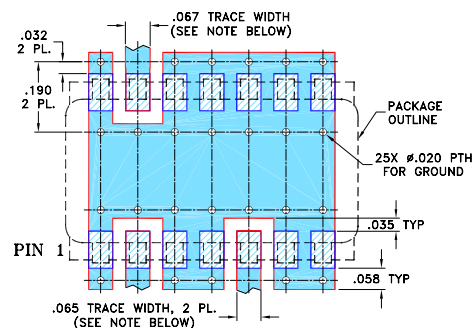

#### Outline Dimensions (inch/mm)

A	B	C	D	E	F	G	H	J	K	L	wt
.505	.800	--	.100	.250	.100	.100	.047	.065	.065	.525	grams
12.83	20.32	--	2.54	6.35	2.54	2.54	1.19	1.65	1.65	13.34	3.0



P.O. Box 350166, Brooklyn, New York 11235-0003 (718) 934-4500 Fax (718) 332-4661 For detailed performance specs & shopping online see Mini-Circuits web site



The Design Engineers Search Engine Provides ACTUAL Data Instantly From MINI-CIRCUITS At: [www.minicircuits.com](http://www.minicircuits.com)

IF/RF MICROWAVE COMPONENTS



REV. B  
M102713  
JTOS-100  
FL/TD/CP  
080415  
Page 1 of 2

# Performance Data & Curves

# JTOS-100+ JTOS-100

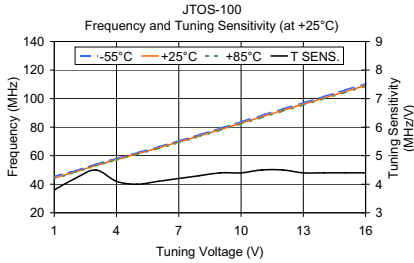

V TUNE	TUNING SENS. (MHz/V)	FREQUENCY (MHz)			POWER OUTPUT (dBm)		
		-55°C	+25°C	+85°C	-55°C	+25°C	+85°C
1.00	3.80	45.55	44.40	43.93	8.98	9.42	9.17
2.00	4.20	49.41	48.60	48.31	9.05	9.40	9.17
3.00	4.50	53.98	53.15	52.83	8.95	9.32	9.08
4.00	4.10	58.08	57.27	56.90	8.80	9.22	8.99
5.00	4.00	62.10	61.31	60.88	8.71	9.12	8.91
6.00	4.10	66.20	65.43	64.96	8.57	8.99	8.78
7.00	4.20	70.43	69.62	69.13	8.43	8.86	8.64
8.00	4.30	74.80	73.93	73.43	8.24	8.67	8.48
9.00	4.40	79.26	78.33	77.81	8.06	8.46	8.26
10.00	4.40	83.78	82.77	82.25	7.86	8.22	8.04
11.00	4.50	88.26	87.23	86.68	7.67	8.00	7.78
12.00	4.50	92.73	91.69	91.10	7.38	7.77	7.51
13.00	4.40	97.13	96.06	95.46	7.21	7.52	7.30
14.00	4.40	101.53	100.45	99.81	6.99	7.31	7.04
15.00	4.40	105.98	104.84	104.18	6.76	7.13	6.85
16.00	4.40	110.43	109.22	108.55	6.54	6.93	6.61

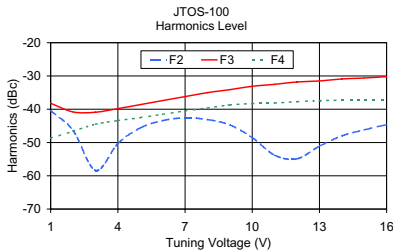
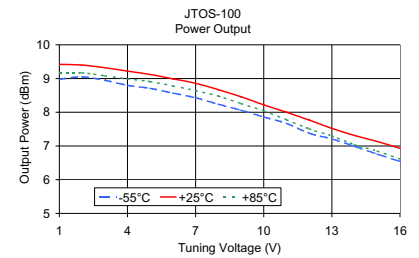

V TUNE	HARMONICS (dBc)			FREQ. PUSHING (MHz/V)
	F2	F3	F4	
1.00	-40.40	-38.20	-48.70	0.02
2.00	-46.40	-40.80	-46.60	0.28
3.00	-58.40	-40.90	-44.50	0.22
4.00	-50.30	-39.80	-43.40	0.15
5.00	-45.60	-38.60	-42.50	0.13
6.00	-43.40	-37.40	-41.50	0.12
7.00	-42.60	-36.20	-40.50	0.15
8.00	-43.10	-35.00	-39.60	0.18
9.00	-44.70	-34.10	-38.70	0.22
10.00	-48.50	-33.10	-38.30	0.23
11.00	-53.80	-32.50	-38.10	0.25
12.00	-54.90	-31.80	-37.70	0.24
13.00	-51.10	-31.50	-37.40	0.23
14.00	-48.00	-30.90	-37.30	0.28
15.00	-46.20	-30.60	-37.30	0.32
16.00	-44.60	-30.20	-37.30	0.40

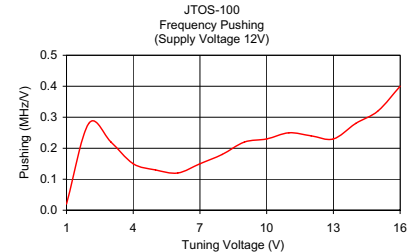

P.O. Box 350166, Brooklyn, New York 11235-0003 (718) 934-4500 Fax (718) 332-4661 For detailed performance specs & shopping online see Mini-Circuits web site



The Design Engineers Search Engine Provides ACTUAL Data Instantly From MINI-CIRCUITS At: [www.minicircuits.com](http://www.minicircuits.com)

IF/RF MICROWAVE COMPONENTS